



# 2024/2025

## POPULAR PRODUCTS

100's more products available  
call or visit [www.ryansautomotive.ie](http://www.ryansautomotive.ie)

Just call to book an on site or  
**Online Demonstration**



or visit us to see the full range  
in our show room.

DIAGNOSTICS <<

INFORMATION PACKAGES <<

SPECIALIST TOOLS <<

AIR CONDITIONING <<

TRAINING COURSES <<

INJECTOR & GLOW PLUG REMOVAL <<

OSCILLOSCOPES <<

SPECIAL OFFERS & MUCH MORE <<

*Diagnostics, Specialist Tools & Technical Know How*

**051 424 799**

visit [www.ryansautomotive.ie](http://www.ryansautomotive.ie)  
email [info@ryansautomotive.ie](mailto:info@ryansautomotive.ie)



**NEXT DAY  
DELIVERY\***

Next Day Delivery starting  
from €12.50. **FREE DELIVERY**  
on orders over €150 ex VAT

All prices correct at time of print but may vary thereafter  
The prices in this catalogue are trade prices for Trade Customers only and do not include VAT.

# Technical Information Systems

## HAYNES PRO

Haynes Pro car and truck Workshop Data complete packages.

# HaynesPro<sup>®</sup>

Haynes Pro serves the automotive aftermarket through Workshop Data. Its database contains a vast amount of multilingual automotive OEM-based data for cars and trucks. Haynes pro is split up into three different modules. Tech, Electronics and Smart and this is what they consist of:



Some information below may not be available on the truck software.



### TECH

- Identification data
- Maintenance
- Adjustment data
- Lubricants and fluids
- Repair manuals
- Recalls
- Repair times
- Technical drawings

### ELECTRONICS

- Includes:
- VESA<sup>™</sup> (Guided diagnostics)
- Comfort Wiring Diagrams
- Fuses and Relays

### SMART

- Known fixes and tips (SmartCASE<sup>™</sup>)
- Technical Service Bulletins (SmartFIX<sup>™</sup>)
- Recalls

Common rail			
Compression pressure			
Normal	35 - 37	(bar)	
Minimum	30	(bar)	
Oil pressure at idle speed	0 - 0.8	(bar)	
Oil pressure	+ 1.8 / 2000	(bar/psi)	
Maximum cylinder head Bolt/torque	0.1	(mPa)	
Drop parts rate (litre) maximum with deposit mass	0.400	(l)	
Drive belt strand			
<b>Emissions</b>			
Emissions			
Max speed maximum	630	(rpm)	
Max speed maximum	870	(rpm)	
Max rpm speed	2300 - 2700	(rpm)	
Oil temperature during test	80	(°C)	
Corrected smoke absorption value	0.0	(m <sup>2</sup> /s)	
Test time	0.5	(s)	
Exhaust gas analysis test method (Germany only)	A		
Fuel consumption, combined usage	8.30 - 8.70	(l/100 km)	
Fuel consumption, extra urban drive	9.10 - 9.70	(l/100 km)	



Enquire about **SPECIAL OFFERS** when combined with a scan tool purchase or subscription

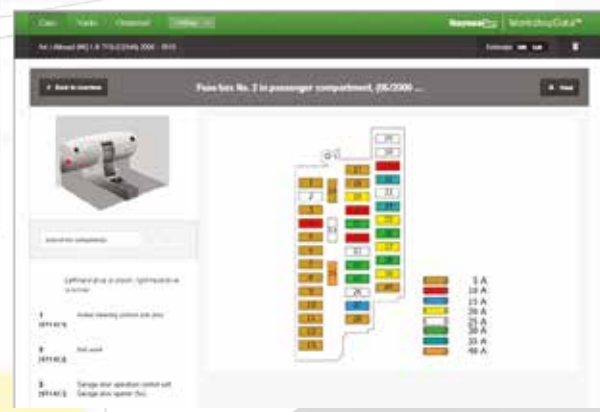

# Technical Information Systems

## GMTO ATIS PRO SOFTWARE



Automotive car brand software with more than 4000 models with electric diagrams, system and component explanation, how to hook up test leads, pre scope adjustments and reference signals for engine management systems.

Atis pro software, detailed vehicle specific info, allowing you to search by specific vehicle giving you some or all of the below information on a huge range of vehicles for engine management systems and in some cases ABS.

- *Wiring diagrams*
- *Specific sensor and actuator tests*
- *Procedures and sample wave forms*
- *Live connection diagrams*
- *Component location information with live pictures*
- *Technical information about the specific item you are testing*
- *This level of information on a scope has never been available before*
- *Note: Atis pro also includes Atis lite generic information.*

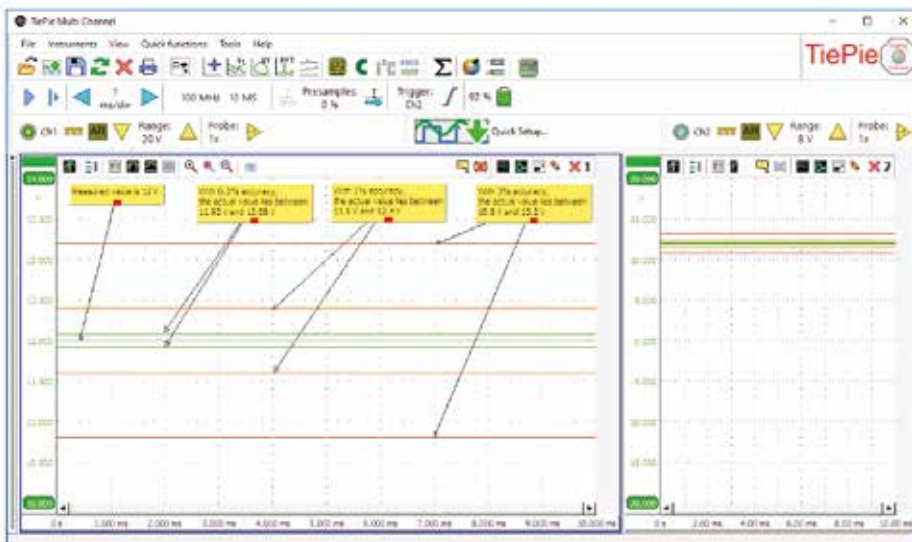
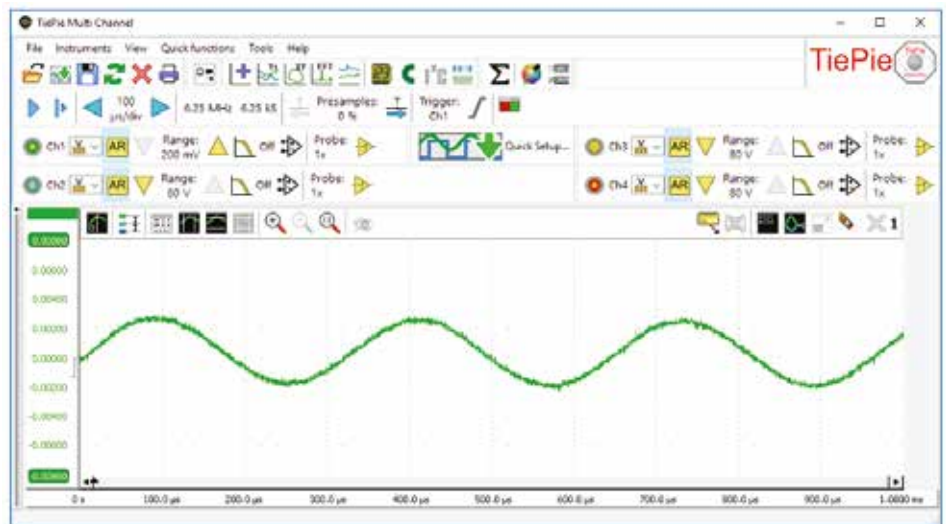

**€554.50**

# Technical Information Systems

DIAGNOSE DAN TSB

# DiagnoseDan TSB

At DDTSB we collect data from large european automotive helpdesk centers. Just on our DDTSB helpdesk we already solve over 50.000 cases annually, that's a lot of data! We analyse this data and look for trends, in other words we look for what fails on specific car models. When we see a trend we start an investigation and create a Bulletin. We make our Bulletins as clear as possible, with explanatory pictures and if available a video. We keep making Bulletins as long as we see a specific model on the road, even if the model is more than 10 years old and it develops a specific problem at a higher mileage or at an olde rage!

This is why we have collected data that is unique and can't be found anywhere else. Finding the right Bulletins can be challenging but in DDTSB it's easy! You can simply enter a licence plate number (available for; UK, Holland, Austria, Germany, Switzerland, Denmark, Spain, Ireland, France, Norway, Sweden, Italy, Finland) you can also search on VIN or select a car manually. After you have selected the vehicle all you have to do is enter a symptom or a faultcode and if it's something that we see frequently on that model, one or more Bulletins will be presented so you know what to look for.

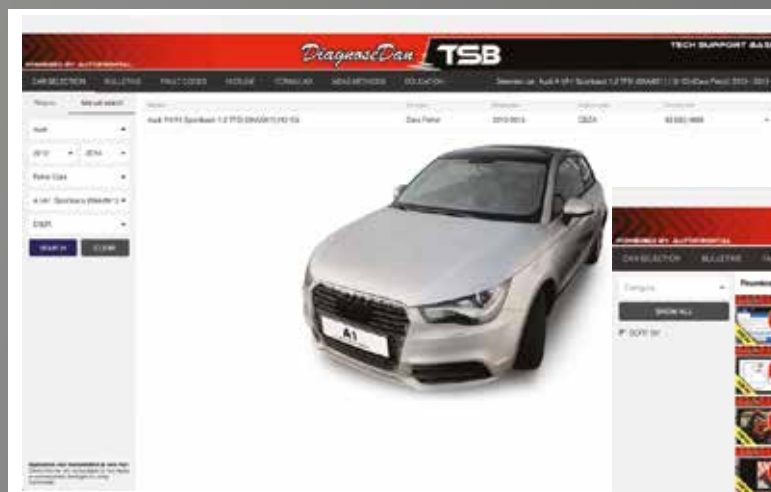

**€385+VAT**  
**12 MONTH ACCESS**



# Technical Information Systems

## Autodata

Autodata is the ultimate tool to provide quick and easy access to technical information to efficiently carry out complex diagnostics and repairs, as well as day to day servicing delivered in an easy to use consistent format for 142 manufacturers covering over 34000 models.



### TECHNICAL FEATURES

- ✓ Complete servicing on one page: all the associated information, all on one page
- ✓ Interactive coloured wiring diagrams
- ✓ Search over 79,000 error codes with the dedicated diagnostic trouble codes module
- ✓ New ASSIST ME function to further aid diagnostics
- ✓ 92,000 wiring diagrams and illustrations
- ✓ 600,000 technical step by step procedures
- ✓ Dedicated Technical Support Hotline
- ✓ Quick, Easy, Informative and always up to date
- ✓ Now includes online training

### PRICING

#### AUTODATA SERVICE AND MAINTENANCE

1 user	product number ADSM1USER	€972 per year/€81 per month
2 user	product number ADSM2USER	€1,128 per year/€94 per month
5 user	product number ADSM5USER	€1,344 per year/€112 per month

#### AUTODATA DIAGNOSTIC AND REPAIR (COMPLETE PACKAGE)

1 user	product number ADDR1USER	€1,620 per year/€135 per month
2 user	product number ADDR2USER	€1,860 per year/€155 per month
5 user	product number ADDR5USER	€2,256 per year/€188 per month

Prices are correct at time of print

## Alldata

### ALLDATA OE TECHNICAL INFORMATION

- ✓ ALLDATA Repair is the industry standard for manufacturers technical information systems.
- ✓ The factory correct information is not edited or redrawn.
- ✓ Unedited repair procedures, diagrams, specifications, component locations, current TSBs, filling quantities, tighten torques, wiring diagrams and much more.
- ✓ Exactly the same as the OE site not changed or modified.
- ✓ All the information that is available on the OE technical information system.
- ✓ No need to sign up to all the individual manufactures TIS websites and pay per view and try to manage 24 different user names and passwords.
- ✓ It is online based so you will always be using the latest version.
- ✓ Unlike other information systems it has all the data just as the name says ALLDATA, not just the most popular information.
- ✓ Become a specialist in the below brands with the correct information at hand.
- ✓ Data currently available for the following brands: Abarth, Alfa, Audi, BMW, Citroen, Cupra, Dacia, Fiat, Ford, Honda, Hyundai, Jaguar, Kia, Lancia, Landrover, Lexus, Mazda, Mercedes, Mini, Nissan, Opel, Peugeot, Renault, Rolls Royce, Seat, Skoda, Smart, Tesla, Toyota, Vauxhall, Volvo, VW.

## ALLDATA REPAIR®



### NEW IMPROVED SEARCH FUNCTION

### PRICING

AllData Repair Standard (1 license)  
€1,740 per year/€145 per month

AllData Power User Package (3 licenses)  
€1,968 per year/€164 per month

# Technical Training Courses at Ryans Automotive

In depth training courses covering both theory and practical knowledge of modern vehicle systems are now available at **Ryans Automotive**. Courses are presented by **Seamus Ryan** who has been involved in vehicle repair and diagnostics from an early age. Seamus has attended train the trainer courses in Ireland, Finland and Holland. Lunch and refreshments provided. Contact us on 051424799 for more information.

## Hybrid and EV 2 Day Training Course

The objectives of this course are that you will have gained the below confidence and knowledge needed when working on Hybrid and EV vehicles

- Be able to identify the different types of Hybrid and Electric vehicles
- How to work safely on Hybrid and EV vehicles
- Have a good understanding of the basic working principles of a hybrid and EV vehicle
- Have a good understanding of the different components of a hybrid and EV vehicle
- Understand the differences and challenges presented in working on Hybrid and EV vehicles
- Perform Service and maintenance on a Hybrid or EV vehicle
- Have a good understanding of how to diagnose and repair hybrid and electric vehicles
- The 1st half of each day will be spent in the classroom and the 2nd half of each day will be spent working on vehicles and components.

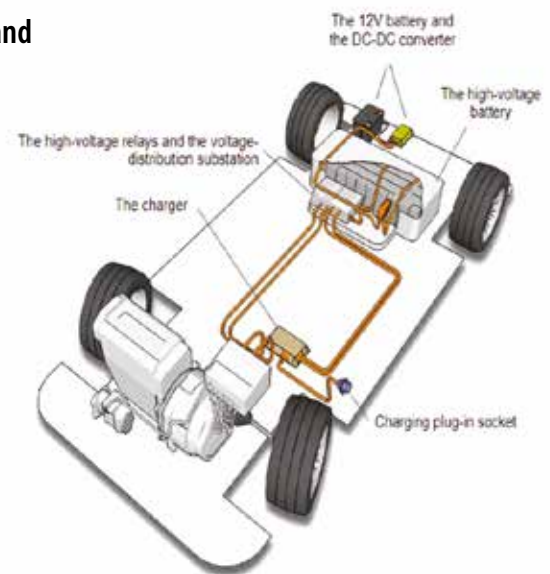

## Hybrid and EV 2 Day Training Course EV3 + EV4

After training 1 and 2, you can work safely and professionally on Hybrid & EV vehicles. The third training goes deeper into Hybrid and EV technology.

The below is what you will learn about in EV3:

- Battery technologies
- Battery pack state of health
- Charging techniques
- Charging stations and charging poles
- Insulation errors
- Diagnosis
- Modern E-motors
- High-voltage heat pumps and air conditioning systems

In EV-4, we will look at the battery pack of a Hybrid/EV vehicle.

The below is what you will learn about in EV4:

- Working safely under voltage (Live working)
- Explanation of battery pack construction.
- Testing the various components in the battery pack.
- Disassembly and assembly work according to manufacturer specifications.
- Cell/Module testing and balancing
- Determining the State of Health of a battery and much more.

# Technical Training Courses at Ryans Automotive

## Common Rail Diesel 2 Day Training Course

This course will take participants through all of the key components and functions of the common rail system, including:

- Advantages and Disadvantages of common rail
- Most popular brands and versions and how they differ and their operation principles
- Low and high pressure fuel supply system.
- Inlet metering and fuel pressure control.
- The high pressure pump and pressure generation.
- Diesel injectors (piezo and solenoid).
- Key sensors and actuators of the common rail systems.
- Typical test for all of the above systems and components

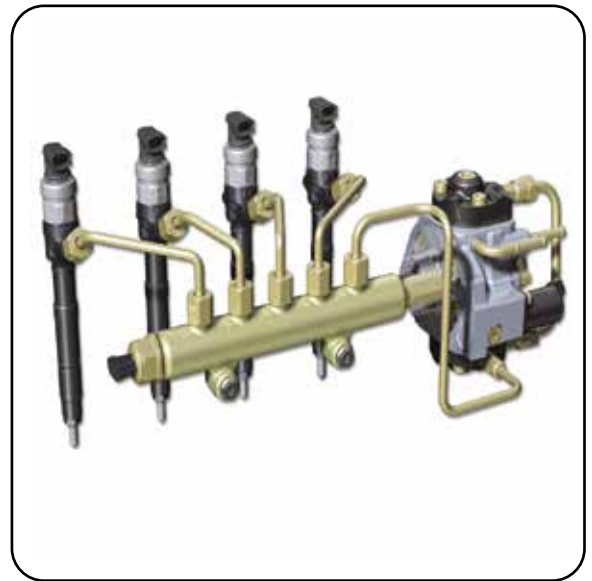

WE WILL COVER THE  
4 MAIN MANUFACTURERS:



**BOSCH**  
Invented for life

**SIEMENS VDO**  
Automotive

**DELPHI DENSO**

## Oscilloscope Training

The objectives of this course are that you will have gained the confidence to connect, test and verify components using an oscilloscope on the day. The first day will be spent in the classroom with the advantage of being able to connect a scope to a test board from the comfort of your desk. The second day will be spent in the workshop connecting to running vehicles performing various tests.

Some of the things it will cover:

- Signal components
- Duty cycle and frequency
- Sensor types and testing
- Actuators types and testing
- Practical test on different components and systems
- How to analyse the signals
- How to use the GMT0 atis pro information system
- How to use the multi channel scope software AND MORE!

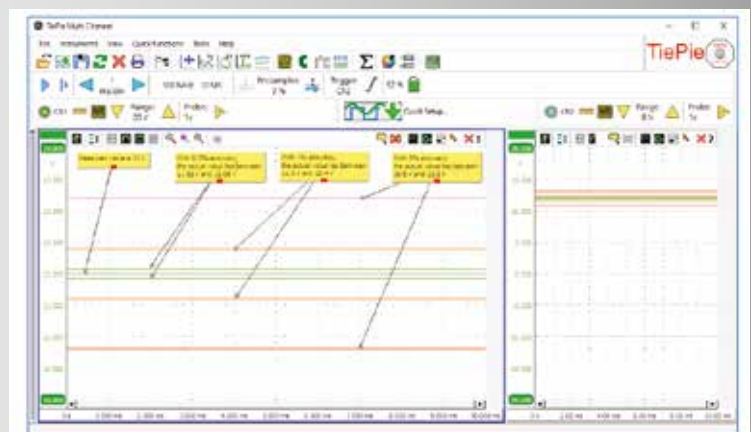

# Technical Training Courses

## 2 Day Oscilloscope Course

- Lunch and refreshments provided
- Full printed course notes provided
- Maximum of 8 people
- Hands on Oscilloscope use
- Suitable for users of any brand of oscilloscope

From oscilloscope basics to checking valve timing and compression tests. This course will set you up to use your oscilloscope effectively.

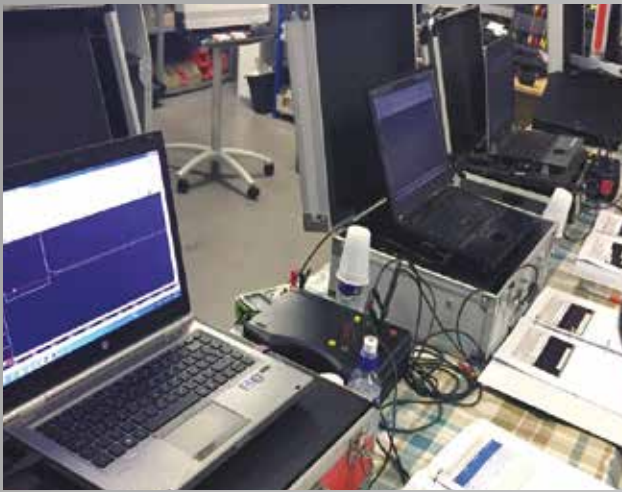

## 2 Day Diesel Intake and Exhaust Systems Course

Covers all aspects of the intake and exhaust system on a modern diesel such as

- Turbo charging
- Low and High Pressure EGR
- SCR and DPF
- All other intake and exhaust components
- And much more
- Lunch and refreshments provided
- Full printed course notes provided

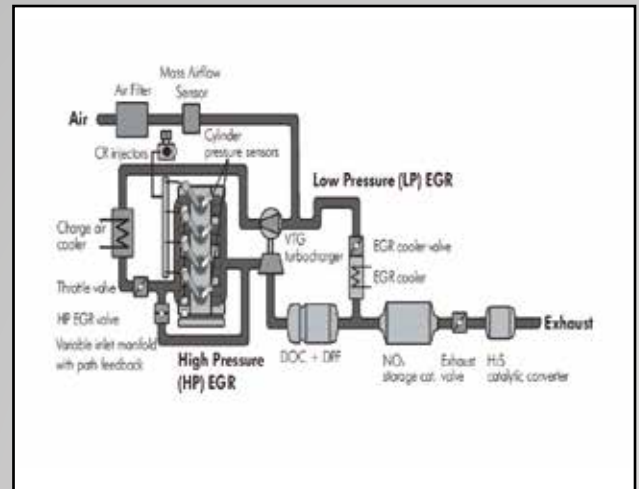

## Autodata Automotive Training



Video based training, online, anywhere, anytime. The world's best technicians depend on ongoing training. Supercharge your technical skills with an Autodata Training subscription. Quality training at your fingertips.

Autodata Training is the automotive industry's leading provider of video-based technical training. Whether you're an individual technician looking to stay ahead of the game or a workshop manager looking to train a team of technicians, we've got you covered.

Over 350 Training Modules in the below categories.

- ELECTRICAL
- CHASSIS
- DRIVER ASSIST
- DRIVETRAIN
- DIAGNOSTICS
- SERVICING
- ENGINE
- HVAC
- HYBRID & EV

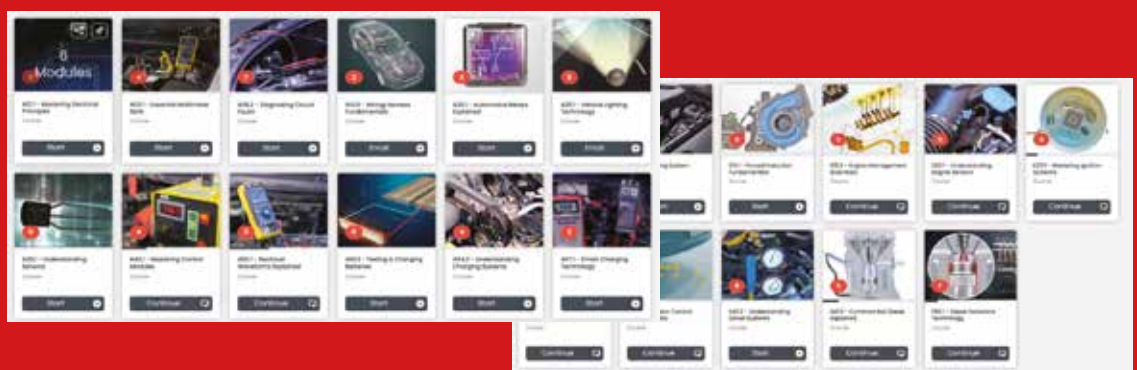



# Prodiags Online Training

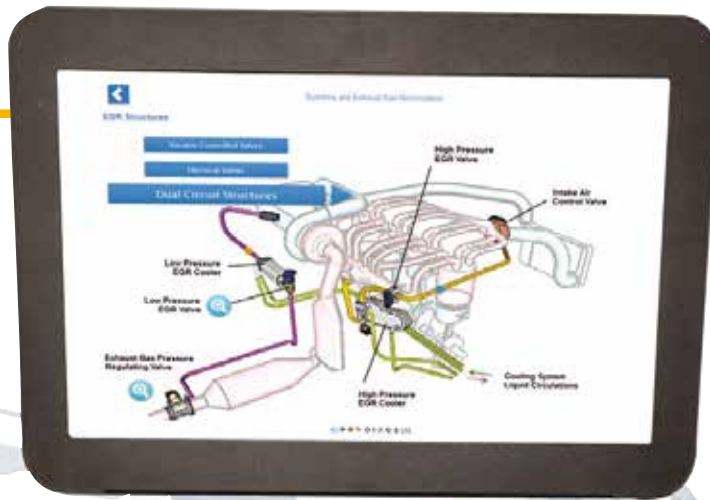

The worlds easiest way to study automotive technology, the following online training manuals are available.

The prices are for 12 months access.

Diesel Exhaust Gas Technology.....	€38
Common Rail Fuel Systems.....	€44
Tyre Pressure Monitoring Systems.....	€32
Hybrid and Electric Vehicle Technology.....	€38
2014 Toyota Prius PHEV Technology.....	€22
Maintenance Service Online Training.....	€38
Tyres, Rims and Tyre Work Online Training.....	€36
EOBD/OBD2 Self Diagnostics.....	€34
Automotive Electricity.....	€32
Automotive Electronics.....	€24
Charging System and Starter Batteries.....	€34
Workshop Safety.....	€16
Workshop Waste Sorting and Recycling.....	€28
Starting and Start-Stop Systems.....	€34
Brake Service and Maintenance.....	€48
Automotive Electrical Troubleshooting Basics.....	€44
Light Vehicle Proactive Maintenance.....	€28
EV Scheduled Maintenance.....	€38
Power Steering.....	€18
Automatic Transmissions.....	€52

**BIG DISCOUNT**  
WHEN ORDERING  
ALL TOGETHER.

GET THE  
**COMPLETE PACKAGE**  
FOR ONLY  
**€379+VAT**



Online training packages for training centres with built in LMS also available, please enquire.

# ADAS Calibration

## SICE/NEXION Group PROADAS

PROADAS is a universal modular system developed for checking and calibration of driver assistance systems, checking the alignment status and complete wheel alignment service (optional) on multi-brand vehicles and light commercial vehicles.

### Now available in several different packages/configurations:

- ✓ ADAS only Start kit
- ✓ ADAS and alignment with an existing CCD or 3D aligner from Nexion Group
- ✓ Full ADAS and Alignment package

### Features

- Compatible with passenger car and light commercial vehicles
- Compatible with vehicle on lifts or other levelled test bay; the software take in consideration the offset where the vehicle is positioned.
- Compatible with Nexion next generation 3D or CCD wheel aligners
- Electrical movement (up/down) of the system.
- Need only 1 user for its use.
- Conforms to or exceeds vehicle manufacturer procedures
- Accurate alignment-positioning of the equipment by the sensors/cameras
- Complete printed report includes ADAS calibration results AND alignment results
- Fast alignment and positioning of the system thanks to Real Time information from the integrated sensors
- Can be used with the other brands and even OE diagnostic equipment
- All in One software. Precheck wheel alignment software to check camber and toe values according to manufacturer's specification's, a condition necessary before any ADAS sensor calibration.

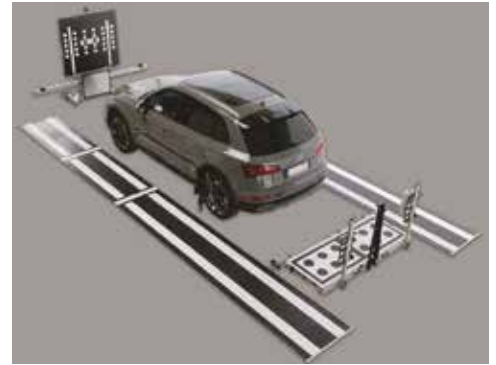

€POA

## MAHLE TechPro Digital ADAS

### Simple and reliable calibration of driver assistance systems

TechPRO® Digital ADAS, MAHLE revolutionary system, is super simple and easy, making maintenance of ADAS systems accessible to all workshops. With the TARGETLESS DIGITAL SYSTEM (patent), no additional panel is required.

- New, innovative, technical, and process-based solution
- Targetless Technology (for forward facing cameras)
- One digital calibration panel, no individual panels and no manual swap-outs required
- Minimizes process times as much as possible
- Excellent, fast, dynamic results
- Always up-to-date with online updates
- Complete Printout report
- Process performed through MAHLE'S TechPro diagnostic system

€POA



# ADAS Calibration

## SmartSafe/Launch iSmartADAS PRO+

ADAS as a comprehensive and flexible calibration tool, The iSmartADAS PRO+ calibration tools a comprehensive and flexible calibration tool that enables you to effectively and accurately calibrate various types of cameras, radars and lidar driving assistance systems, such as front lane departure warning system, radar sensors for adaptive cruise control and much more.

**The iSmartADAS PRO+ comes in 4 kits: Basic, Standard, Deluxe and Premium**

### The Basic Kit

The basic kit includes VW – LDW LAM 01-02 for calibrating forward facing cameras for LDW lane departure warning on VAG group vehicles and we have also included the ACC reflector and mounting plate for calibrating the front radars on VAG group vehicles. And as you require later you can add the other LDW targets, radar targets, NVS targets (night vision targets), AVM (around view monitoring) targets and other optional targets.

From  
**€6,600**  
+VAT

### The Standard Kit

The standard kit includes all currently available panels for calibrating forward facing cameras for LDW lane departure warning system etc and we have also included the the ACC reflector and mounting plate for calibrating the front radars on VAG group vehicles.

And as you require later you can add the other radar targets, NVS targets (night vision targets), AVM (around view monitoring) targets and other optional targets.



From  
**€8,550**  
+VAT

### The Deluxe Kit

The deluxe kit includes all currently available panels for calibrating forward facing cameras for LDW lane departure warning system etc. And also includes radar targets. And as you require later you can add the other NVS targets (night vision targets), AVM (around view monitoring) targets and other optional targets.

From  
**€9,950**  
+VAT

### The Premium Kit

The premium kit includes all currently available panels for calibrating forward facing cameras for LDW lane departure warning system etc. And also includes radar targets, RCW and AVM (around view monitoring) targets.

From  
**€12,950**  
+VAT

*There is some other optional targets that are not included in the set but they can be added at any time.*

# 4 Wheel Alignment

## SICE A926E CCD-Radio 4 Wheel Alignment System

- Wheeled and mobile, with closed compartment for pc and printer
- Measuring sensor with 2 high resolution cameras, electronic inclinometer and level
- Wireless data transmission
- Extremely low light sensitivity for working even in very bright light conditions
- Measuring sensor body in cast aluminium for extreme precision
- Data bank with more than 40,000 vehicles, updatable every year
- Run-out compensation with manual spin or raised wheels, real time measurement and adjustment of caster and king pin inclination (KPI).
- Easily viewed screen and printout
- Fast, precise and very reliable:
- Made by Nexion Group Company
- User friendly software for precise and quick alignment measurements
- A first class international based databank

UP AND RUNNING PRICES

From  
**€7,650.00**  
+VAT



## SICE A92E 3D 2 Camera alignment system

- Fast, precise and very reliable
- Made by Nexion Group Company
- User friendly software for precise and quick alignment measurements
- Intuitive 2-key operation with easily accessible tutor help
- Easy access to all adjustment values
- 10" to 26" sensor holder (with adaptor)
- Front infrared filter for enhanced immunity to solar reflections.
- Superior Quality Camera. Latest generation high-resolution HI-Q camera for artificial vision
- Lift Drive-On Assistant by remote camera for easy vehicle positioning (optional).
- NEW INTEGRATED LIFT WITH WORMGEAR AND SAFETY SYSTEM
- Lift level automatic tracking function (optional)
- A first class international based databank
- Live graphic indications
- Chassis measurement data
- Factory-calibrated, calibration checked only upon installation, no periodic calibrations required
- Job operation customer data bank, to recall and memorize all customer data
- Camera movement for working from ground to 2 meter height (optional)

UP AND RUNNING PRICES

From  
**€8,950.00**  
+VAT



SICE IS PART OF NEXION GROUP, ONE OF THE WORLD'S LARGEST MANUFACTURERS OF WORKSHOP EQUIPMENT

## SMARTSAFEWA

Making four wheel alignment faster, more accurate and more labour saving. The X-861 Pro 3D wheel aligner is an intelligent 3D four wheel aligner that can collect wheel alignment data at ultra high speeds and high precision from the vehicle.

- Automatically adjust the height of camera beam electrically to follow the vehicle on the lift
- HD Camera lens with temperature compensation function
- Simpler alignment procedure with LED indicator
- Start to use in seconds, no more tedious work of pre-calibration.
- Body & Chassis and tire diameter measurement.
- 50000 + global vehicle model database
- 8 to 12 cm rolling compensation, saving time and effort
- The whole machine is movable and can be shared by multiple stations
- Supports standard measurement and quick measurement, can measure key parameters such as toe-in, camber, caster angle, kingpin inclination, thrust angle, etc, supports wheelbase, wheelspan, and axle deviation. additional measurements such as shift, wheel offset, diagonal, center offset, etc
- Support measurement report saving and printing



UP AND RUNNING PRICES

From  
**€6,950.00**  
+VAT

# Oscilloscopes

Check out [www.ryansautomotive.ie](http://www.ryansautomotive.ie)  
for different kits & accessories available



## GMTO/TIEPIE HS6 Diff 4 Channel Oscilloscope

" One of the most advanced scopes on the market with user friendly set up and automotive software that will not be matched."

INTENSIVE  
TRAINING  
COURSES  
AVAILABLE

### TECHNICAL FEATURES

- ✓ 5 different models/speeds available
- ✓ Up to 1 GS/s sampling speed
- ✓ 250 MHz bandwidth
- ✓ USB 3.0
- ✓ 4 channel switchable differential or offset scope!
- ✓ XM: With the extended memory option, up to 256 M Samples memory per channel is available.
- ✓ S: The SureConnect, connection test and resistance measurement are available on all channels.
- ✓ G: The SafeGround, the differential inputs can be switched to single ended inputs, with a protection against shorts circuits to ground. Optional on 1 Gs/s model.
- ✓ Spectrum analyser and serial/CAN bus pro-tocol analyser
- ✓ 1 year warranty as standard on main scope unit and option to buy 5 year warranty for €65.00
- ✓ Comes with Atis Lite Automotive Software with over 1000 component tests and preset screens.
- ✓ Fully differential

FREE

Setup & half day training



FROM  
**€1,395**

All prices excluding VAT

## AUTOMOTIVE TEST AND INFORMATION SYSTEM

### ATIS PRO SOFTWARE IS AN AUTOMOTIVE TEST AND INFORMATION SYSTEM

Detailed vehicle specific information, allowing you to search by specific vehicle giving you all of the below information:

- ✓ Wiring diagrams for Engine Management
- ✓ Specific sensor and actuator tests
- ✓ Procedures and sample wave forms
- ✓ Live connection diagrams
- ✓ Component location information with live pictures
- ✓ Technical information about the specific item you are testing
- ✓ This level of information on a scope has never been available before.
- ✓ New online database where all Atis users can share waveforms.

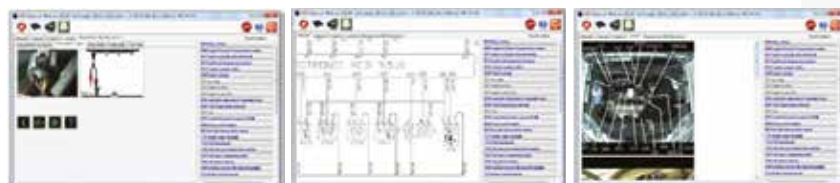

**€554.50**

\* NOTE: This can be purchased and used without owning a GMTO Scope

### OPTIONAL CUSTOM CARRY CASE

Specifically designed Carry Case for GMTO/TiePie oscilloscopes and accessories



# Oscilloscopes, Diagnostic Accessories and More

Part No.: BPS

## BACK PROBE SET

Colour coded back probe set 4mm includes 8 probes  
These thin and flexible measuring probes fit on any test lead with 4 mm banana jacks and make it possible to connect to hard to reach places.

€49.50



Part No.: MPS4500

## GMTO PRESSURE TRANSDUCER BASIC KIT

Allows you to perform the following tests:  
 • Dynamic in cylinder pressure testing with the engine running or cranking. The waveform captured then allows you to perform an analysis of the cylinders compression, timing, valve condition, exhaust back pressure and more.  
 • Measure fuel pressures up to 45 bar  
 • And any other air or fluid pressure you wish to test up to 45 bar



€599.00

Part No.: 181

## LOAD PRO TEST LEADS & TROUBLESHOOTING BOOK

• Use with your multimeter to quickly load and test circuits  
 • Comes with 200 page electrical troubleshooting book

SCAN ME for more product info



€84.00



Part No.: 688

## LOW CURRENT CLAMP METER

• Full digital multimeter included  
 • 19mm clamp size  
 • Cat III 600 Volts Safety Rating  
 • Accurate down to 1mA/0.001A

IDEAL FOR BATTERY DRAIN

€285.00



## TEST LEADS AND ACCESSORIES

Much larger range available on our website  
[www.ryansautomotive.ie](http://www.ryansautomotive.ie)

Part No.: B2031



## 92 Piece Test Lead Set

€179.00

• Uses all 4mm BNC connectors  
 • Can be used with any scope or multimeter.  
 • Easily bypass wiring looms for test purposes  
 • Connects to most connectors without causing damage

Part No.: PPS



## Pressure Pulse Sensor

€79.17

Use in conjunction with a Ditec scope to check the following:  
 • Pulsation of exhaust gases in the exhaust  
 • Changes in the gas pressure in the inlet manifold  
 • Fluctuations in the membrane pressure regulator of the fuel  
 • Crankcase gases and other

Part No.: 7223



## Terminal Release Tool Set

€176.00

• Includes 24 different release tools.  
 • Made by Condor Germany

Part No.: 142-2



## Bed of Nails Test Clamps

€18.50

• Series of very small pins = less wire damage  
 • Compatible with any test leads that use the standard 4 mm banana connection

Part No.: TP-CC80



## 20/80 Amps Clamps with Female Connections

€105.00

• 20/80 Amps clamp with female 4mm banana connection  
 • Universal use with any brand of scope or DMM

Part No.: CA15

## AUTOLAND SINGLE CHANNEL SCOPE/MULTIMETER



• Extremely easy to use and fast single channel scope meter/multimeter  
 • Ideal for the novice scope user or the experienced user who wants a robust and fast scope  
 • Heavy duty leads  
 • Extremely fast and easy to use  
 • Built in scope auto set up for large range of components and tests  
 • 3.6 volt rechargeable battery Li-ion battery  
 • Max measuring voltage DC220V and AC250V

€495.00

Part No.: CSV1

## CARSCOPE VISO 2 CHANNEL OSCILLOSCOPE



### Key performance specifications:

- 2-channel oscilloscope
- Each channel has its own independent ADC
- Advanced hardware trigger
- 8k point record length on all channels
- Up to 20 MS/s sample rate on each channel

€649.00

Part No.: 616

## SPOON BACK PROBES

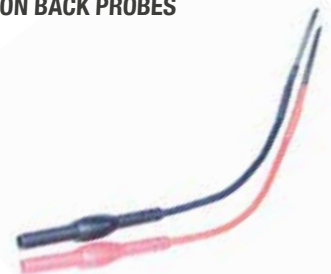

• Curved probes allows back probing of round electrical connectors, especially weather pack style.  
 • Another great option for non-intrusive testing  
 • Tap readings and scope signals without damaging electrical connectors and harnesses  
 • Connects to standard size 4mm banana plug test leads

€16.24

Many more scope accessories available, visit [www.ryansautomotive.ie](http://www.ryansautomotive.ie)

# Battery Management Equipment

## GYS FLASH 100

Part No.: GYSFLASH100-12HF5MT



GYS 100AMP Battery Support Unit with 5 meter cables

- Battery support: sustains 12V (liquid or gel) automotive battery during diagnostic work
- Advanced battery charger ensures an ideal charging cycle for battery maintenance for the most modern vehicle
- Showroom mode: maintains batteries in showroom vehicles
- In 'battery change mode', will maintain electrical supply to preserve vehicle memory settings
- High power stabilized supply: voltage & current adjustable
- Approved by many OEM manufactures

€832.00

## GYS Flash 120 Amp

Part No.: GYSFLASH120

GYS 120 amp Battery Support Unit with 5 metre cables.



### Main Features:

- The new big brother of The Flash 100amp
- Many manufacturers including BMW, Jaguar, LandRover and Mercedes now recommend a 120 amp support unit when programming.
- Supports Wet, AGM and Lithium type battery
- Comes with 5 metre cables.

€998.00

## GYS Diagnostic Trolley

Part No.: GYST



Diagnostic Trolley

- Diagnostic cart with 3 shelves/levels, top shelf suitable for laptops, diagnostic tools or oscilloscopes etc and middle shelf for battery support unit and lower shelf for storing other equipment.
- This new revised version now includes a handy pole for holding leads from the battery support unit or oscilloscope that you are using

**SPECIAL OFFER AVAILABLE**  
WHEN YOU PURCHASE BOTH UNIT AND TROLLEY

€408.84 +VAT

## Battery Charger Sirius 16 - 12/24 Volt Part No.:019030



SIRIUS ultimate electronic charger, digital, multiphase of charge and maintenance. Suitable for all types of lead batteries Wet, Gel, AGM, MF, Vrla, etc.

- 12 and 24 Volt
- 16 Amp
- Show room function
- Supply/memory saver
- Recovery
- And much more

€174.73 +VAT

## 12 Volt Lithium Booster Pack GIGA

Part No.: 05390



Ultralight and high performance booster for professional use Not your average light duty personal use booster, ideal for use in workshops and car sales outlets Recommended for all 12V batteries.

€332.00

### Made in Italy by Electromem

#### Features:

- Memory Saver Special Function • Weight 3.5kg
- Equipped with cables with insulated clamps and digital display with functions indication.
- Peak ampere 4000A • Continuous current 800A • Start max amperage 2000A
- Reverse polarity protection and warning • Short circuit protection
- Voltage error warning • Overload warning • Over discharge warning
- Over charge warning • Over temperature warning

## Electromem Flash

Part No.: 805650501C

120 Amp Battery Support Unit and Charger



### Main Features:

- Comes with 6 meter cables
- Can supply up to 120 amps during battery support for diagnostic and programming
- FlashMem 120 produces three different charge cycles, Wet, AGM or Lithium LifePO4
- Equipped with micro processing CPU controller for the control and the top safety of all operations
- Automatic cycle of desulphation and exclusive function for deep discharged batteries.

### Fully Safe System:

- Reverse polarity
- Short circuit
- Voltage error
- Overload

€898.00

## Battery Tester XP900 with printer

Part No.: XP900 (without printer)  
XP900KIT (with printer)



- Report Test printable via in built printer (optional)
- Backlit display
- Rugged and shockproof structure
- USB / USB port

- It controls the state of 12 V batteries that comply with different standards: SAE, DIN, EN, IEC, JIS.
- Battery types, WET, GEL, AGM, MF, VRTA and SLI
- Battery tester function 12V
- Starter tester function 12/24V
- Alternator tester function 12/24V
- Vehicle mass Voltage drop test
- Report Test printable with the client and company name via PC software by connecting with PC via USB cable

€298.00 with printer

## ThinkCar Diagnostic Cart

Part No.: TCTROLLEY



- Strong durable castor wheels and handles for easy moving
- Suitable for battery support equipment and other equipment
- Flat top for diagnostic equipment
- Spacious drawer and shelves

€495 +VAT  
Excludes shipping fee of €55 +VAT

## ThinkCar THINKPPS 150 Battery Support Unit Part No.: PPS150



- Programming power supply
- Fast charging
- Battery activation and repair
- Exhibition mode and jump start mode.
- Stable power supply for programming programming
- 150 amps in battery support mode

€895 +VAT

# Transmission Cleaning

The number of vehicles with automatic gearboxes has risen sharply in recent years. The recommendation is to service the gearbox system every 60,000 km / 37,500 miles, on average.

Only with the right equipment can this be done correctly, with all the oil replaced, unlike traditional ATF servicing. Vehicle manufacturers recommend servicing automatic gearboxes:

1. To avoid high secondary costs in the event of problems
2. To extend the service life of automatic gearboxes
3. To maintain good vehicle performance
4. To prevent malfunctions due to wear and contaminated ATF
5. To ensure a more comfortable ride

## Mahle FluidPro ATX250 ATF Machine

**PART NUMBER: 1010320083XX**



**€3,895 + VAT**

- Integrated Database & Technical Information.
- Automatic Detection of oil flow.
- Guided recovery/recharge processes.
- Zero Cross-Contamination function.
- Inspection windows: allows you to visual control over the oil quality.
- 25 l interchangeable tank for new ATF with quick coupler.
- Adaptor Kit 1-17 included. Additional adaptors available separately.

## Mahle FluidPro ATX280 ATF Machine

**PART NUMBER: ATX280**



**€4,850 + VAT**

### THE SAME AS THE ATX250 BUT WITH THE BELOW EXTRAS

- 7 inch touchscreen display
- FluidPRO® ATX Remote Viewer App: can be activated, allowing the operator to freely control all running steps.
- Built-in Dipstick function
- Boost function: which boosts used oil drainage, speeding up oil change operations.
- Quick Discharge function
- WiFi connection: enables the connection to the WEB Databank (included in the first year), constant updates and remote assistance (Re.Solve), as well as the possibility to print the final report directly from your workshop's PC (Nexus Print).
- High Quality instructions
- supported by detailed images of each procedure.
- Adaptor Kit 1-17 included. Additional adaptors available separately.

## SmartSafe/Launch CAT-601S ATF Machine

**PART NUMBER: CAT601S**



**€1,950 + VAT**

The CAT-601S is delivered with a base adapter set to connect to some of the most common gearbox units, including dual clutch and CVT types and optional adaptor sets or individual adapters are available on request. The CAT-601S auto transmission cleaner and fluid exchanger can complete the flush and fluid exchange very quickly on a transmission, torque converter and radiator. The fluid exchange rate is nearly 100%

## Geatek KAR Roller Cabinet With ATF Adaptors

**PART NUMBER:  
GEA13997**

Most comprehensive adaptor kit on the market. This Geatek Kar roller cabinet comes stocked with ATF adaptors that are made from aluminium and are also laser engraved to ensure you know where they are when you need them. Made in Italy, Geatek design and make a wide range (more than 100 pieces, more than 60 applications) of automatic transmission adaptors. Our adaptors are specifically design to connect your equipment to the vehicle in the easiest and quickest way possible. Each adaptor is laser engraved with its number so you can easily recognize it. You can find a step by step procedure on how to connect adaptors to the vehicle (i.e. where and what to disassembly to access the connection point) in our online transmission maintenance manual: Gea Idea.



**€1,995 + VAT**

## Geatek ATF Technical Information Software

**PART NUMBER:  
GEA11000**

Years of research together with the daily experience gained in the workshop have allowed us to create Gea Idea: the online manual for transmission maintenance. Gea Idea is a complete, easy-to-consult online software that contains information relating to the automatic transmission of over 10,000 versions of cars and light commercial vehicles, becoming a tool that helps the technician in his daily work. For each vehicle sought, the following are provided: • Type and overall quantity of oil • Spare parts needed such as filters and gaskets • Step-by-step instructions with diagrams, illustrations and photos on how to connect the flushing equipment to the gearbox • Shows the type of fittings and tools for each type of gearbox • Form for making a quote to the owner of the vehicle



**€199 + VAT**

**For more information scan the qr code**







# HEV and EV Equipment

## Electrical Safety Gloves

**PART NUMBER: IG**

- Needed for working on Hybrid and Electric vehicles
- For electrical work with a maximum voltage of 1000 volts
- Class 0
- To be used with leather protectors
- Available in 3 different sizes 9, 10 & 11



**€55-€69 +VAT**

## Sofamel Rescue Pole 1.75m 45kva

**PART NUMBER: BS-45**

- For rescuing electrified victims in case of an accident when working on Hybrid and electric vehicles
- 1.75 metre length
- Maximum voltage 45kva
- Hand protective grip



**€92.60**

## Danger High Voltage Sign

**PART NUMBER: DHVSL and DHVSS**

- Made from rigid plastic
- Large sign = 297 x 420 mm
- Small sign = 148 x 120 mm
- Thickness 1.2mm



**€15.50 - €36**

## Lockout Hasp 38mm Diameter

**PART NUMBER: ALH38**

- Lockout device for High Voltage electrical connection
- Used with standard padlock (padlock not included)
- Made from spark resistant aluminium



**€7.76**

## Restricted Area Marking Poles

**PART NUMBER: HPS06**

Kit for marking out restricted area when working on hybrid and EV

- Plastic support posts and bases for marking out restricted areas
- Posts are made from high density Polyethylene
- Posts are fitted with chain support caps
- Chain length 25 meters



**€179 +VAT**

## Class 1 Arc Flash Helmet

**PART NUMBER: ARC3**

- Helmet with retractable face shield.
- This safety helmet, constructed from a high impact polyamide, is designed to protect against the thermal hazards of electric ARC
- The face shield comes with an Anti-Fog and Anti-Scratch premium coating.
- It also boasts a protective chin piece for added protection against an arc flash hazard



**€159**

## CLASS 3 Insulating Matting

**PART NUMBER: ISM1M**

For reliable protection for reducing the risk of electric shocks when working on Hybrid and electric vehicles.

- INSULATING MATTING (IEC 61111) – CLASS 3
- Insulated matting marked in conformity with the IEC 61111 requirements
- Working voltage: 26kV
- Withstand voltage: 40kV



**€78.59**

## 3/8 Drive Socket Set

**Insulated to 1000V**

**PART NUMBER: FG624E/S10**

Includes the following:

- 8, 10, 12, 13, 14, 17 and 19mm sockets
- Ratchet
- Extension x 2



**€191**

## High Voltage Multimeter

**PART NUMBER: HPS03**

- Safe up to 1000 volts
- Amps up to 20 amps
- Huge range of multimeter functions



**€198**

## MilliOhm measuring instrument

**PART NUMBER: MM3000**

- To be used with GMTO/Tiepie Oscilloscopes
- Tests resistance of motor coils
- Inbuilt presets and information



**€426**

## Electrical Insulation Tester

**PART NUMBER: MT1801**

- Loads the circuit to test for electrical insulation
- Also used for testing Piezo Common Rail Injectors
- DMM Features (AC/DC voltages, resistance & continuity)
- CAT III 1000 V and CAT IV 600 V overload protection



**€218**

**EV TOOL PACKAGES AVAILABLE - Many More EV Products in stock.**



# HEV and EV Equipment

## NRGkick Fix Max 32A 5m EV Charger

**Insulated to 1000V**

**PART NUMBER: 12501015**

The Fix Max charger is a fixed charger also with the option to make it portable using the adaptors provided, these include 13amp outlet, 16amp outlet, 16amp 3 phase outlet and a 32amp 3 phase outlet giving you charging rates up to 22kW.

**CLAIM UP TO €300 BACK ON THIS CHARGER WITH THE SEAI HOME CHARGER GRANT**

**€1,213 + VAT**



## EV Charging Cable Type 2 To Type 2 5M - 32A 3ph 22kW

**PART NUMBER: 028999**

- Electric-vehicle charging cables provide convenient car-charging anywhere you are.
- Guarantees your car battery stays full and ready to go.
- Equipped with a Type 2 terminal (European standard).
- Compatible with a wide range of electric vehicles, including Mercedes, Audi, BMW, Volkswagen, Opel, Volvo, Toyota, Tesla, Peugeot, and Renault.
- Safe and reliable, designed to resist general wear and tear.
- Built to withstand outdoor elements (IP66 class).

**€270 + VAT**



## Govini Mobile Battery Lifting Table GO1500T

**PART NUMBER: GO1500T**

This is a universal lifting table that has fork housing with a shifting, extendable & tilting table that can hold up to 1.5 Tonne and it also comes with fork housing and an extendable handle.



## SmartSafe/Launch LT150 EV Battery Lift

**PART NUMBER: LT150**

- With a rated lifting capacity of up to 1.5T, it meets the needs for most electrical vehicle battery disassembly and installation in the market.
- Utilizing laser materials and robot welding to ensure high precision and quality.
- Powered by an asynchronous AC motor, the hydraulic gear pump drives the cylinder with the assistance of balancing support bars, ensuring smooth lifting and lowering.
- Equipped with heavy duty 360 degree swivel casters for easy mobility. The platform surface is fitted with rubber insulation pads to prevent maintenance personnel from coming into contact with electricity.
- This model has a movable table, which is convenient for screw alignment during battery installation, and can be adjusted within a range of 40mm from front to back, left and right.

- This model can also tilt by 4 degrees



**€2,950 + VAT**

## iSmartEV P03 Hybrid & EV Diagnostic Tool & Battery

**PART NUMBER: P03**

### Pack Tester

- Integrate four kinds of detection tools: Battery pack detection, scan tool, integrated oscilloscope, multimeter, insulation tester, and current clamp, covering the common measurement and diagnostics requirements in the maintenance scene of new energy vehicles.
- "Original level" detection of the battery pack: Support reading the current SOC/SOH, single/module voltage, input/output current and power, battery temperature, and other parameters of the battery pack.
- Innovative detection by quick charging port: Read battery pack data by connecting to the quick charging port for faster battery detection.
- Battery Diagnose: Plug directly into the battery with the direct fit or universal cable to do more in-depth tests on the battery (this feature is in development and does not have this feature for all EV and Hybrid cars yet).
- Three battery pack detection methods: Support connecting through special connectors, through jumper, and OBD, which provide more choices for users.

- Superb all-round vehicle coverage: Coverage for US, Asian, and European brands.
- Near OE-Level Diagnostics: Includes all your normal diagnostic functions, including special functions like adaptation resets, etc., for a huge range of makes and models.
- Online ECU Coding: Make software modifications to customize systems (also known as Retrofits and Conversions) for some systems and models on the following brands: BMW E and F series, VAG group, Toyota, Porsche.
- Cloud-based ECU Programming: For BMW, BENZ, VW/AUDI/ SKODA/ SEAT, PORSCHE, LAND ROVER/ JAGUAR, SUBARU, NISSAN, and RENAULT without the need for the manufacturer's software (for coding and programming, it covers a huge range of systems and models in the above brands, but we don't claim all).



**€3,250 + VAT**

## iSmartEV EP401 Battery Charger/Discharger

**PART NUMBER: EP401**

- Charge/discharge test: Adopting a wide voltage design, it is suitable for charging and discharging tests of battery modules of different voltage levels. Supports various lithium batteries and nickel metal hydride batteries.
- Health assessment: Support battery health status assessment, unique software algorithm to obtain SOC/SOH value.
- Single unit and terminal voltage collection: Supports real-time acquisition of pack terminal voltage and individual cell voltage.
- Single battery core protection: Cell current and voltage protection thresholds can be set to prevent overcharge and over-discharge.
- Terminal charging and discharging protection: Supports overvoltage, undervoltage, overcurrent, output short circuit, reverse connection protection, and overtemperature protection.
- Data visualization: During the charging and discharging process, the voltage of each single cell, terminal voltage, terminal current, the charging and discharging status, the charging and discharging capacity, etc., are monitored in real time.



**€7,500 + VAT**

# Electrical/Electronic Test Aids

Part No.: AS7180

## AUTOSIM PRO

- Combined Sensor Simulator and PWM Generator
- Precise DC Voltage control
- Embedded sensor presets
- Simulates actual working condition of most automotive sensors
- Master kit also available



€287.10

Part No.: HU31035

## HUBITOOLS SENSOR SIMULATOR

- Combined Sensor Simulator and PWM Generator
- Easily rule out wiring issues
- Simulates most sensor types on the market
- Runs many actuators like egr, etc



€399.00

Part No.: CSIT

## CARSCOPE I-TESTER

Quickly and easily perform the following functions,

- Relative Compression Test
- Cylinder synchronisation
- Common Rail Pressure Test
- Optional OBD cable also available €20
- Master kit also available



€284.00

Part No.: TMX589

## TECH MULTIMETER KIT

€289.00

Set Includes:

- Over 1 Hour of DVD video training included, including videos by Dan Sullivan
- TMX-589 True RMS Digital Multimeter – CATIII 1000 Volt
- LOADpro® Dynamic Test Leads
- 200 page Electrical Troubleshooting Book
- Compass for Alternator and solenoid diagnostics



# TEST LEADS AND ACCESSORIES

Part No.: PPECB



## Power Probe OBD Breakout box and tester

€199.00 +VAT

- Test all 16 pins in the OBD port
- Test for power supply and grounds in OBD port
- Allows you to switch the inbuilt voltmeter to display the voltage on the various pins
- Many more functions. Check our website for more details

Part No.: MM101



## ThinkCar Borescope ES401

€297.50+VAT

The Borescope ES401 is also an ultimate tool for automotive and home inspectors. This is a special tool for detecting narrow spaces that are hard to reach, like car evaporators, combustion chambers, and three-way catalytic sensors. Featuring two lenses of 0.25in and 6 adjustable LEDs, it provides excellent visibility in dark and tight spaces. The 2MP HD industrial Borescope is also equipped with a 5" IPS Screen that enables users to insert small probes into a small area and transmit clear, vibrant, and all-around video.

Part No.: HU23135



## Hubitools Handy Borescope/ Videoscope 4.9mm

€512.00 +VAT

- 4.9mm head
- Front and side switchable cameras
- 2 Led lights sources and 2 cameras
- AV Out port
- Zoom x 1.5

Part No.: 316



## Relay Fuse Buddy

€106.05 +VAT

- Is it a circuit problem or a relay problem?
- Relay Fuse Buddy can help diagnose the case
- In-circuit bypass switch controls power downstream of relay
- Displays live circuit current – 20 Amps continuous
- 30 Amps momentary
- Turn on and off DC motors, fuel injectors, fuel pumps and see the amp draw
- Enhances your circuit & relay test capabilities
- Wide coverage – includes adapters for 6 different relays

Part No.: RSB7210



## Automotive Resistance Substitution Box

€79.45

- Device for simulation, inspection and testing applications of all car resistor type sensors
- Easily simulate resistances of 0 to 10000 ohms
- Quickly confirm the fault of a sensor and the integrity of the wiring loom.

Part No.: HU35025

## HUBITOOLS UNIVERSAL DIGITAL PRESSURE TESTER

The ultimate Pressure test unit. Replaces dozens of standard pressure testers in just 1 unit.

Test the following:

- Diesel and Petrol compression
- Oil pressure
- Turbo pressure
- Cooling system pressure
- AD Blue pressure
- Fuel low pressure
- Vacuum pressure
- Particle filter pressure
- And as an option, common rail high pressure

Many optional adaptors now available

€1,409.34

### Features

- ✓ Sensor 0 to 300Bars
- ✓ Sensor 1 > 3Bars
- ✓ Universal Diesel Compression Adaptor for injector hole
- ✓ 2 x types of nozzle head for diesel compression adaptor
- ✓ Petrol Compression Adaptors x 2
- ✓ One way valve
- ✓ Eight specific professional quick coupling adaptors
- ✓ Coned adaptors for connecting to rubber push on hoses x 6



Much larger range available on our website  
[www.ryansautomotive.ie](http://www.ryansautomotive.ie)

# TPMS

## TPMS Starter Kit 2

### PART NUMBER: TPMSK2

- ✓ Ateq TPMS Programmer with OBD cable
- ✓ 3 years updates included
- ✓ 10 x HUF Intellisens Universal Sensors
- ✓ TPMS Online training
- ✓ TPMS Tool kit
- ✓ Programs a wide range of universal sensors



**€465.63**

## SmartSafe/Launch iSmartTool ST06 With 3 Years Updates

### PART NUMBER: 601MAX

Diagnostic tool that also has a battery tester and TPMS with coverage for over 98% of vehicles with tire pressure sensor activation and matching learning. Tire pressure data reading: pressure, tire temperature, battery status, etc. Reading/coping/writing sensor ID value, compatible with OE and Launch and Thinkcar universal sensors.



**€695+VAT**

\*Tyre pressure sensors not included

# EMISSIONS TESTERS

## MAHLE EmissionPRO Diesel/Petrol Emissions Tester

### PART NUMBER: MEMPRO

Mahle petrol and diesel emissions tester. Scan for more info:



**€5,250+VAT**

## MAHLE EmissionPRO Petrol Emissions Tester



Without Trolley **€2,950+VAT**

With Trolley **€3,150+VAT**

The MAHLE EmissionPRO Petrol Emissions Tester analyser can work both statically and dynamically, by sampling emissions at the exhaust pipe using the supplied probe designed for this purpose. With the intuitive operator panel, users have all the functions of the exhaust gas analyser at their fingertips, and can easily swap from independent measurements to the legally specified test.

# LEAK DETECTION

## Rainco ALT400 Automotive Smoke Leak Detector

### PART NUMBER: ALT400

- Dual Mode (Smoke Mode & Air Mode)
- Inbuilt mini air compressor, instant smoke generation
- Self-protection system keeps machine away from overload
- Easy operation and quick locating the leak parts
- For Various Motor Vehicles
- It can change special oils (Baby Oil & Mineral Oil) into smoke
- It can produce large volumes of smoke quickly
- EVAP: 15 KPa



**€345+VAT**

## Rainco ALT500 2 In 1 Automotive Smoke Leak Detector

### PART NUMBER: ALT500

- MCU Control with LED Display • Double Pressure Gauges • Double Flowmeters • EVAP Test Mode • Turbo Test Mode • Dual Mode (Smoke Mode & Air Mode) • Inbuilt mini air compressor, instant smoke generation
- Self-protection system keeps machine away from overload • Easy operation and quick locating the leak parts • For Various Motor Vehicles • It can change special oils (Baby Oil & Mineral Oil) into smoke • It can produce large volumes of smoke quickly • EVAP: 5-8 KPa
- TURBO: 0.8-1.20 Bar



**€595+VAT**

## Rainco ALT550 3 In 1 Automotive Smoke Leak Detector

### PART NUMBER: ALT550

- MCU Control with LED Display • Double Pressure Gauges • Double Flowmeters • EVAP Test Mode • HD Test Mode • Turbo Test Mode • Smoke Test Mode
- Dual Mode (Smoke Mode & Air Mode)
- Inbuilt mini air compressor, instant smoke generation • Self-protection system keeps machine away from overload • Easy operation and quick locating the leak parts • For Various Motor Vehicles • It can change special oils (Baby Oil & Mineral Oil) into smoke • It can produce large volumes of smoke quickly
- EVAP: 5-8 KPa • TURBO: 0.8-1.20 Bar
- HD: 2-8 Bar



**€795+VAT**

## ThinkCar PLD 212 EVAP Smoke Machine

### PART NUMBER: PLD212E

- Output Pressure: 3-6 Psi
- Flow Amount: 8-15L/Minute
- Oil Volume: 45ML
- Supply Voltage: DC 12V
- Flow Adjustment: Support



**€372.89+VAT**

## ThinkCar PLD 212 Turbo Smoke Machine

### PART NUMBER: PLD212E

- Output Pressure: 13-16 Psi
- Flow Amount: 8-15L/Minute
- Oil Volume: 45ML
- Supply Voltage: DC 12V
- Flow Adjustment: Support



**€360+VAT**

## REDLINE DETECTION.COM

Part Number: EIB  
EASY INTAKE BLADDER

Great Time Saver



**€129.00**

\*Inflatable bladder to connect your smoke machine to non circular pipes.

# Adblue, DPF and DEF Equipment

Check out our website for the full range [www.ryansautomotive.ie](http://www.ryansautomotive.ie)

## Errecom DPF Flush kit

**PART NUMBER: RK1350**



**€201.41**

Kit includes,

- DPF Flush Gun
- DPF Flush 5 litre
- DPF Rinse 5 litre
- The above 5 litre cans are enough fluids to do 5 vehicles each
- Interchangeable rigid probe
- Interchangeable flexible probe

## Refractometer for Adblue testing

**PART NUMBER: RFM03AB**



**€85.67**

- For testing of Adblue quality
- Approved by Mercedes
- Made by LTR Germany

## Sampling and Concentration Test Kit for Adblue

**PART NUMBER: AEKP01**



**€348.12**

- Includes adblue Refractometer
- Tests the delivery rate of the scr pump
- Tests the injected quantity
- Approved by Mercedes

## Diagnostics, Flushing and Cleaning Kit For Adblue Systems

**PART NUMBER: LE-UNAB06**

- Dosage quantity measurement (in conjunction with vehicle tester)
- Spray pattern check
- Discharge pressure measurement
- Visual inspection in the pipe circuit
- Component flush
- Exhaust/filling of empty pipes and pumps
- Solving of crystals
- Oil detection in AdBlue®
- Vacuum indication at conveyor module
- Cleaning of dirty SCR tanks and pipes
- Operating the vehicle with AdBlue® from a canister
- The adapter kit is 100% resistant to AdBlue®
- Made by Lehnert Tools Germany
- Approved by AGCO



**€1,495**

## Gauge to Check the Pressure and Vacuum of Adblue

**PART NUMBER: FP07AB**



**€225.69**

- Made by LTR Germany
- Completely resistant to Adblue
- Reads positive and negative pressure
- For reading pressure and line clearing (negative)

## Gauge Set To Check Pressure And Vacuum Of Adblue Pump

**PART NUMBER: AEKP04**

- Gauge reads positive pressure and negative pressure which allows you to check the operating pressure and also to check the line clearing on systems where the pump sucks the Adblue back into the tank when the vehicle is switched off
- measuring range -1...+15 bar
  - compound gauge NG 63



**€379+VAT**

## DPF Pressure Tester

**PART NUMBER: JOTFP**

- Range: 0-1000mBar
- Resolution: 1mBar
- Accuracy: ±1.5%
- Display: Colour TFT / 480x272 pixels
- Power Supply: Li-Po rechargeable battery 3.7 V /1000 mA
- Charge: By USB port using the included cable



**€169+VAT**

# MAVEL EXTENSION REELS | High quality, made in Italy



Part No.: 811200



**Roll Classic 230v Energy Reel**  
€143.00

- Automatic spring rewinding
- Plastic outer casing. • Steel swivelling wall bracket. • 230 Volt. • Cable length = 10 meters. • Cable size = 1.5mm<sup>2</sup>. • Ratcheted stop device easily inspectable and removable by the end user. • CE approved. • TUV approved

Part No.: 811350



**Roll Classic Plus 12V Light**  
€175.00

- Cable length = 15 meters
- Automatic spring rewinding
- Plastic outer casing
- Steel swivelling wall bracket
- Ratched stop device easily inspectable and removable by the end user
- CE approved

Part No.: 826300



**Roll Dynamic Air Reel**  
€131.06

- Hose length = 12 meters
- Automatic spring rewinding
- Plastic outer casing
- Steel swivelling wall bracket
- Ratched stop device easily inspectable and removable by the end user
- Inlet outlet fitting size is 1/4
- CE approved

Part No.: 811600



**Roll Classic Plus 15m ETHERNET/LAN Cable**  
€465.00

- Cable length = 15 meters
- Automatic spring rewinding
- Plastic outer casing
- Steel swivelling wall bracket
- Ratched stop device easily inspectable and removable by the end user
- CAT 5E
- CE approved

Many More Models Available

## Common Rail Diesel Test Equipment

scan code for  
Must see video



Part No.: JOCR1600CF



**Fuel Rail Blanking Plugs**  
€69.00

- Allows you to blank each cylinder when testing a common rail system
- 6 of M12 X 1.5
- 6 of M14 X 1.5

Part No.: JOCR1600FRN



**Dummy Regulators Kit**  
€129.00 +VAT

- Ideal for testing pumps and regulators
- Bosch CP1, CP3 & CP4
- Delphi DFP1 & DFP3
- Denso HP1, HP2 & HP3
- Siemens DCP type 1 & 2

Part No.: JPCRK



**Common rail high pressure test kit**  
€695.00

- Common rail high pressure gauge and hoses to connect to most popular systems
- Set of 8 dummy regulators
- Fuel rail blanking plugs set
- Inbuilt overpressure relief valve

Part No.: A2252



**Injector Leak Back Test Kit**  
€96.36

- 24pc injector adapters
- 6 measurement bottles with tubing
- Heavy duty measurement tubes with hanging chain

Part No.: LR180AK2



**LTR Analog Tester with Sight Glass**  
€445.65

- Gauge reads -1 to +9 bar
- Clear sight glass to check for air.
- Quick release connectors sets X7
- Brand: LTR Germany

Part No.: 4759



**Flair Nut Sockets for injector Pipes**  
€79.00

- Used to open and tighten hard to reach injector pipes
- Sizes 12mm, 14mm, 16mm, 17mm, 18mm and 19mm

Part No.: HP



**Injector Test Hand Pump**  
€499.00

- Made by LTR Germany
- Develop 600 bar pressure
- Comes with 2 different size pipes
- Other models available

Part No.: 4789



**Fuel Line Blanking Set**  
€79.00

- 2 x male connector 8 mm
- 2 x male connector 3/8"
- 2 x male connector 10 mm
- 2 x female coupler 8 mm
- 2 x female coupler 3/8"
- 2 x female coupler 10 mm

Part No.: LE-UNKR0602



**Heavy Duty Lehnert Leakback Kit**  
€1295.00

- Connects in circulation mode
- Vehicle can be run for long periods
- Tests return pressure
- Extensive adaptor kit
- Suitable for Piezo Injectors

Part No.: CRE04



**Containers for determining Injector Volume**  
€76.21

- Injection volume
- Damaged or leaking injectors
- Blocked injectors
- Stuck open injectors

# Engine & Fuel System Tools

scan code for  
Must see video



Part No.: WT-11999



**Mechanical Vacuum and Pressure tester**

**€ 99.23**

- Vacuum and pressure tester
- Brake Bleeding kit included

Part No.: WT-111011



**Fuel System Pressure Test Kit**

**€ 265.00**

- 0 to 10 bar
- 42 different connectors
- 2 size Schrader connectors

Part No.: BPT01



**Back Pressure Test Kit**

**€ 81.06**

- Quickly identify blocked cats/dpfs
- Universal O2 port adaptor

Part No.: AET-800337



**Diesel Compression Tester**

**€ 364.79**

- 20 x Glow plug adaptors
- 4 x Injector adaptors
- 1 x universal injector adapter set
- 1 x 90 degree connector

Part No.: JOCTD



**Digital Turbo Pressure Tester**

**€ 195.00**

- Test pressure and Vacuum
- From Minus 1 to plus 3 bar
- View in a graph or Numerical
- Easy to connect due to special needle system

Part No.: FG170/S3



**Plastic Hose Clamper Pliers**

**€ 30.62**

- Includes 3 different sizes

Part No.: 832

Great time saver



**Oxygen Sensor Thread Repair Kit**

**€ 75.58**

- Includes 1 tap
- 1 Insert tool
- 6 repair inserts
- Replacement inserts can be ordered separately (part no 833)

Part No.: A2063



**Petrol Compression Test Kit**

**€ 64.63**

- Main gauge with quick coupling
- M10 X 1.0, M12 X 1.25, M14 X 1.25 and M18 X 1.5 adaptors
- 2 test pipes with rubber sealing cones

Part No.: GO647

THIS Works without engine cranes or transmission jacks



**Engine Support with Telescopic and Rotating Arms**

**€ 385.45**

- Load capacity 400kg
- Height adjustable non slip rubber pads

Part No.: FG189/S13



**Boost Leak Tester**

**€ 163.71**

- Universal use
- Quick release air line connector
- Built in adjustable pressure regulator
- Connect to shop air with standard tyre pressure gauge/pump. • Includes the following size adapters : 31, 38, 46, 51, 55, 60, 65, 70, 75, 80, 85, 90 mm.

Part No.: LT450



**CO2/Head Gasket Leak Detector**

**€ 113.91**

- Includes main tester unit
- Reaction & Rinsing fluid
- Wooden carry case.
- Replacement reaction fluid in stock. • Brand: LTR, Germany

Part No.: JOCRG



**FSI/GDI Digital High Pressure Tester**

**€ 220.00**

- Test low and high pressure circuits of GDI/FSI systems
- Comes with flexible attachment hoses. • 0 - 200 bar range
- Scales - Bar and PSI

Part No.: AET-350L



**Cooling System Pressure Tester**

**€ 191.25**

- 15 radiator/expansion tank adaptors
- Hard wearing plastic case
- Brand: Fasano, Italy

Part No.: 36680



**Vag Water Pump And Gear Removal Kit**

**€ 87.13**

- Includes pulley for removing water pump gear
- Water pump remover
- Tool for turning crankshaft
- Used for VAG 2.5TDI

Part No.: OP85



**LTR Germany Oil Pressure Test Kit**

**€ 154.16**

- PSI and Bar
- 10 adaptors with quick release
- 1 angular adaptor

100's more products available on [www.ryansautomotive.ie](http://www.ryansautomotive.ie)

# TIMING TOOLS

Over 90 different timing tools in stock

Part No.: A1392



Timing Tool BMW N40/  
N45 Engines

€ 198.00

- Suits 1 series E81 AND E87 and 3 Series E46 and E90 1.6

Part No.: C01/0275



Timing Tools For, 1.0, 1.2, 1.4 &  
1.5 TSI VAG Group Petrol Engines

€ 595.00

- This timing tool uses a battery-powered digital inclinometer in conjunction with precision-made adapters and alignment tools to ensure camshafts are set to the manufacturer's specifications.
- Suitable for engine codes: DADA, DFYA, DHFA, DPCA, DACA, DPBA, DACB, DPBE, DXDB, and many more.

Part No.: FG192/F016



Timing Tool Ford 1.0  
Ecoboost

€ 331.54

- Suits engine codes M1DA; M1DD; M1JA; M1JE; M1JC; M2DA; M2DB; M2DC; M2GA; P4JA; P4JB; SFJA; SFJB; XMJB; XMJA; M1CA; M1CB; SFCA; SFCB

Part No.: FG192/LR8



Timing Tool JLR 2.0GTDI  
Petrol

€ 192.59

- Suits
  - Jaguar: XE, XJ, XF
  - Land Rover: Discovery Sport, Freelander 2
  - Range Rover: Evoque
  - Engine: 2.0 GTDI
  - Engine code: 204PT

Part No.: FG192/VW2



Timing Tool 1.2TSI VAG  
Petrol

€ 43.51

- Suits engine codes CBZA, CBZB, CBZC
- OEM Numbers T10340 and T10414

# STEERING AND SUSPENSION

Part No.: G0360



Multi Steering Knuckle  
Spreader Tool

€ 208.66

- Allows you to easily spread a joint for the removal of seized components
- Used for ball joints, shock absorbers, steering knuckles, etc
- Avoids having to use a hammer and possibly damaging components.

Part No.: 8-33100050



Steering Wheel Level Tool

€ 99.91

- Assures a level steering wheel during the alignment procedure
- Easily calibrated

Part No.: ADS0001347



Ford Rear Trailing Arm  
Bush Tool

€ 240.00

- Covers 2 types of bushings
- Ford Focus MK1 and MK2
- Ford Mondeo/S-Max/Galaxy/C-Max/Kuga

Part No.: E2183



Universal Bushing/Joint  
Removal and Install Kit

€ 357.85

- Can also be used with a hydraulic piston

Part No.: HU42025



Lugdriller Locking Wheel  
Nut Remover

€ 298.00

- Works on all types of nuts and studs from any brand
- Also works on all modern cars with oddly shaped lugs
- Also works on damaged lugs

051 424 799 | visit [www.ryansautomotive.ie](http://www.ryansautomotive.ie)  
email [info@ryansautomotive.ie](mailto:info@ryansautomotive.ie)

# TRANSMISSION AND DRIVETRAIN

Part No.: 318010000



Self Adjusting Clutch  
(SAC) Master Kit

€ 555.61

- Essential for the correct removal and refitting of SAC clutches
- This is the master kit. Lesser kits also available.

Part No.: MHK1



Muller Werkzeug Hub Kit

€ 344.00

- Base kit for multi-use
- Use with Hydraulics, Sliding Hammer and Axle play detector
- Optional extras available

Part No.: FG198/DF



Hydraulic CV Joint  
Remover

€ 211.44

- Easily remove seized CV joints
- Can also be used to remove tight brake drums

Part No.: ADS0001736



Generation 2 Wheel  
Bearing Tool for  
Sprinters and Crafters

€ 419.61

- Suitable for Sprinters and Crafters 2006 on with 96mm bearing.
- Please note hydraulic piston is not included.

Part No.: ADS0003017W0PAP



Generation 2 Wheel Bearing Tool For  
Citroen, Peugeot, Toyota Proace  
And Opel Vivaro

€ 395+ VAT

- Citroen Jumpy from 2016
- Peugeot Expert from 2016
- Toyota Proace and Proace Verso from 2016
- Opel Vivaro from 2019
- Please note hydraulic piston is not included

www.ryansautomotive.ie



# LTR GERMANY BRAKE FLUID SERVICE TOOLS



## Main Brake Fluid Service Unit

- Suitable for all types of brake fluid
- Sleeplessly adjustable pressure from 0 to 4 bar. • 230 volt power supply
- Holder for 5 litre brake fluid container on the rear. • Pump cuts in and out automatically. • 3.5 metre long hose. • Comes with B611 popular adaptor to suit a large range of vehicles. • Comes with a brake bleed container and hose for old fluid.

**€685<sup>00</sup>**

## LTR Brake Fluid Service Unit With Cart

- The same as the Main Brake Fluid Service Unit but it comes with a cart
- Contains a suction pump for draining master cylinders before removal.
  - Contains space to house a 20 litre drum of brake fluid.

**€1,150 +VAT**



## BRAKE FLUID SERVICE ADAPTOR KIT

- Adaptors made from machined aluminum
- All adaptors have a 90 degree quick release connection and can swivel through 360

- degrees.
- Includes 6 adaptors of which 3 can be adjusted by 5mm to suit a wider variety of cylinders.

**€395<sup>00</sup>**



## DIGITAL BRAKE FLUID TESTER

- Test and print the vehicles brake fluid water content and boiling point in minutes.

- Tests DOT 3, DOT 4 and DOT 5 brake fluids. • Comes with pc software for an official print of your results.

SELL YOUR  
BRAKE FLUID  
SERVICE

**€360<sup>00</sup>**



## ASK ABOUT MULTI DEAL SPECIAL OFFERS

### BRAKE REPAIR TOOLS

Huge range of similar products available on [www.ryansautomotive.ie](http://www.ryansautomotive.ie)

Part Number: 456200

#### VW BRAKE CALIPER GUIDE REPAIR KIT



- Special drill TIN coated
- M9 X 1.25 tap
- 10 threaded inserts M9 X 1.25
- Drilling guide
- 7mm allen key

**€171.72**

Part Number: ADS0000470

#### BRAKE BLEED NIPPLE REPAIR KIT



- Contains 2 size drill bits
- 2 taps
- 13.4 x 90 degree countersunk tool
- Locktite
- 1/4 and 1/8 bleed nipple adaptors

Save yourself the cost of a new caliper with a few minutes work.

**€153.12**

Part Number: 463020

#### BRAKE PIPE FLARING TOOL



- For use directly on the vehicle or on the bench
- Works with aluminum, copper, copper nickel and steel lines
- Sizes 4.75, 5.00 and 6.00mm lines
- Made by Muller Werkzeug Germany

**€183.00**

### COIL SPRING COMPRESSORS

051 424 799 visit [www.ryansautomotive.ie](http://www.ryansautomotive.ie) email [info@ryansautomotive.ie](mailto:info@ryansautomotive.ie)

Part No.: G0312



#### Pneumatic Coil Spring Compressor

**€1,950+VAT**

- Auto Leveling System The two auto leveling upper arms allow to work easily both on conical and misaligned springs. • Cylinder: Stroke & Power: It is possible to use this auto leveling machine also in case of long shock absorbers thanks to its 330 mm stroke. With a working pressure of 8 bar the machine exerts a compression force at 1226 kg without losing power. • Brackets system: The frontal and lateral clamps' holders grant quick mounting and dismounting replacement both of the clamps and of the vice. • Pedal and safety guard with safety valves • Tools Rack • Machine supplied with vice to cover most of the absorbers for cars on the market (optional brackets can be added at any time later) • Compression force: 8 bar = 1.226 Kg

Part No.: G0320



#### Pneumatic Coil Spring Compressor

**€3,150+VAT**

- Comprehensive safety concept
- Jaws are plastic-coated for quick, tool-free jaw replacement.
- Wide range of movement from 20 mm up to a maximum opening width of 330 mm.
- Auto Leveling System
- Brackets system: The frontal and lateral clamps' holders grant quick mounting and dismounting replacement both of the clamps and of the vice.
- Pedal and safety guard with safety valves
- Protective cage is equipped with perforated panels
- Tools Rack
- The practical absorber drop guard keeps the absorber in position during installation.
- Machine supplied with small 78 to 130 mm and medium bracket 105 to 185 mm and small vice to cover most of the absorbers for cars on the market
- Compression force: 8 bar=2000 Kg

Part No.: G0325



#### Pneumatic Coil Spring Compressor

**€3,250+VAT**

- Comprehensive safety concept
- Auto Leveling System
- Brackets system: The frontal and lateral clamps' holders grant quick mounting and dismounting replacement both of the clamps and of the vice.
- Pedal and safety guard with safety valves
- Protective cage is equipped with perforated panels
- Tools Rack
- Machine supplied with vice to cover most of the absorbers for cars on the market (optional brackets can be added at any time later)
- Compression force: 8 bar=2000 Kg

Part No.: 321061000



#### PISTON PULLER/LOCKER FOR GAS SHOCKS

- Special kit for mounting shock absorbers with stop buffers
- Pull up the shock and lock in position so you can easily mount the plate and mounting.

**€297.68**

Part No.: 321090000



#### SHOCK ABSORBER SPRING LOCKING TOOL

- Used with a spring compressor to clamp the spring to the bracket
- Anchors the spring, avoiding accidents or injuries.
- Plastic scratch proof coat to protect the spring coat.

**€88<sup>00</sup>**

# Glow Plug Removal Tools

scan code for information



## GLOW PLUG BODY REMOVAL KIT

This is an advanced set to cover all different scenarios and works with a sliding hammer system that does not require a flat surface on the head

Part number: 311227004  
COMPLETE KIT: M8x1, M9x1, M10x1, M10x1.25

**€ 1149.00**

## New Modular System | This kit is available in 4 different modules



**MODULE 1: Part No.: 311227000 (13 pcs.)**  
It contains the BASIC tools required to be able to use each specific Module for each glow plug size: M8x1, M9x1, M10x1, M10x1, 25.

**€ 402.73**



**MODULE 2: Part No.: 311227001 (5 pcs.)**  
It contains the tools required to remove the M8x1 glow plugs. To be used in combination with the BASIC modular tool kit 311227000.

**€ 259.24**



**MODULE 3: Part No.: 311227002 (5 pcs.)**  
It contains the tools required to remove the glow plugs M9x1. To be used in combination with the BASIC modular tool kit 311227000.

**€ 269.47**



**MODULE 4: Part No.: 311227003 (7 pcs.)**  
It contains the tools required to remove the glow plugs. M10x1 M10x1.25. To be used in combination with the BASIC modular tool kit 311227000.

**€ 390.00**

Part Number: GO451

### MASTER KIT FOR GLOW PLUG TIP REMOVAL



- Suitable for when the glow plug tip is broken in the head
- Covers 8mm, 9mm, 10mm x 1 and 10mm x 1.25 glow plugs
- Threaded puller type also available

**€ 513.22**

Part Number: FGA332/AN

### 90 DEGREE AIR DRILL



- 90 degree air drill for drilling glow plugs.
- Great for tight areas

**€ 115.00**

Part Number: 600289

### GLOW PLUG IMPACT & SOCKET SET 1/4 DRIVE



- The impact wrench produces impact momentum in turning direction, acting like a hammer stroke on the screw connection; these strokes are executed over 50x per minute with max. 40 Nm (with 8 bar) in loosening mode, thus causing the corrosion and carbonisation to break open

- Adjustable loosening torque in 4 modes: 10 Nm / 20 Nm / 30 Nm / 40 Nm
- Made by Muller Germany

**€ 221.00**

Part No.: GO453



Some times the glow plug will screw out so far but will not pull out of the head this is normally caused by carbon build up or the body of the glow plug is deformed

### Deformed Glow Plug Puller

- This system quickly and directly grips the hex body of all types of M8 M9 M10 glow plugs
- Features the innovative FAST LOCK SYSTEM that ensures maximum quickness
- Does not damage the cylinder head and guarantees a professional job

**€ 288.48**

Part No.: FG72/GMC1 & FG72/GMC2



### Short Ratchet Tap Holder

- Ratchet tap holder for tapping glow plugs
- Available in M3 to M8 and M5 to M12 sizes

**€ 16.52**

Part No.: FG183/S5



### Special Sockets for Glow Plugs

- Swivel joint for hard to reach glow plugs
- 8mm, 9mm, 10mm, 12mm, 14mm 1/4 drive sockets

**€ 68.30**

Part No.: 297001

**€ 138.00**



### Micro Die Grinder

- The latest generation mini composite device for small/fine grinding and milling
- Minimal vibration and low noise
- 70,000rpm
- Provides perfect handling due to the Bionigrip anti-slip surface

**PLUS**

Part No.: 297001/KIT5  
**€ 129.00**



### Micro Die Grinder Tips

- Set of 5 Carbide milling and grinding burrs
- Spares can be ordered in packs of 3

# Injector Removal Tools

Part No.: HPWG

\* Prevents overloading your injector removal kit



Hydraulic Hand Pump with Gauge. 700 Bar

€ 435.00

- Builds 700 bar pressure
- Includes the correct fitting for Muller, Govoni and Pichler pistons
- Made by Muller Werkzeug Germany

Part No.: 3344



Injector Seat Cutting and Cleaning Set

€ 245.90

- Comprehensive universal cutting and cleaning set
- Includes injector washer extractor
- Suitable for Bosch, Delphi, Denso and Siemens

Part No.: GO405



Universal Injector Removal Set

€ 1298.76

- Extraction type Hydraulic or Mechanical
- Hydraulic cylinder included (or can be purchased without)
- Adaptors included for Bosch, Denso, Delphi and Siemens
- Suitable for all 16valve (flat top) engines

Part No.: ADS4



Heavy Duty 15kg Sliding Hammer

€ 228.38

- Monster sliding hammer, best used with 2 people.
- Comes with Bosch coil type adaptor
- Adaptors available for Bosch Piezo, Delphi, Denso & Siemens

Part No.: A2209



Budget Injector Seat Cutter

€ 76.34

- Suitable for Bosch, Delphi, Denso and Siemens
- 15mm, 17mm, and 19mm

Part No.: 290206



Vibro Air Impact Hammer Kit

€ 321.65

- Helps loosen injectors
- Endless other uses
- Comes with 4 adaptors and a wall mount.

Part No.: ADS0002106



Injector Washer Removal Tool

€ 65.06

- Screw design for better grip on washer
- In built sliding hammer

Part No.: GO425



Mercedes Bosch Injector Removal Kit

€ 259.00

- Suitable for 2.1, 2.2 and 3.0V6 CDI

Part No.: GO403



Special Adaptors for Denso Injectors

€ 499.00

- No need to dismantle injectors
- Includes 5 different adaptors for Denso injectors.

ADS 0001007



Delphi New Type Injector Removal Adaptor

€ 83.88

- Suits Delphi new type flat top injectors

Huge range of Injector removal equipment on [www.ryansautomotive.ie](http://www.ryansautomotive.ie)

## Renault M9R Injector Removal



Part No.: ADS0000806

RENAULT M9R PIEZO INJECTOR REMOVAL KIT

- Specific kit for M9R engines
- Special double grip adaptor and threaded shafts
- Special tools for removing broken injector nozzle included.
- Special sockets x 2 for twisting out injector if top has broken off.

Instruction manual and first class advice and support

€ 895.00

Part No.: GO434

€ 659.75+VAT

Common Rail Injector Removal Tools For Ford 2.0 Ecoblue

- Set of special tools to remove the injector of FORD 2.0 ECOBLUE
- Suitable for Ford 2.0 ecoblue TDCI from 2016 (Ford Galaxy, S-max, Mondeo, Focus C-Max, Transit and Custom (from 2018), etc



Part No.: ADS0001075

OPTIONAL ADD ON KIT FOR M9R BOSCH COIL TYPE INJECTORS

- Add on kit to ADS0000806
- For M9R engines from 2010 on

€ 140.42



# Customer Support



All our products are tested in house so that we have an in depth knowledge of everything we sell. Be it phone support, online support or product replacement while your own is being repaired (when available)

we won't let you down. Our Online Knowledge base and Support Library contain a host of information on vehicle problems and product information and downloads.



More more information visit [www.ryansautomotive.ie](http://www.ryansautomotive.ie)



**Excellent aftercare service.  
Expert staff who know what they are talking about**

**HUGE RANGE OF PRODUCTS ON OUR WEB SHOP [WWW.RYANSAUTOMOTIVE.IE](http://WWW.RYANSAUTOMOTIVE.IE)**

## SERVICES

- ✓ Specialist Diagnostic Centre
- ✓ Injector and Glow Plug Removal
- ✓ DPF Cleaning and Diagnosis
- ✓ Performance Tuning
- ✓ Electric Power Steering Unit Repairs
- ✓ Immobiliser Decoding
- ✓ ECU Cloning
- ✓ Automatic Transmission Flushing and Cleaning
- ✓ Petrol Injector Testing and Cleaning including Direct Injection
- ✓ Hybrid Battery Reconditioning
- ✓ FRM Module Repair

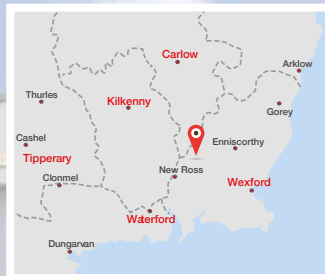

## OPENING HOURS

**Mon - Fri: 9am to 5.30pm  
(Closed from 1pm-1.30pm)  
Saturday: Closed  
Sunday: Closed**

## HOW TO FIND US?

**Address: Ballindoney,  
Ballywilliam, Enniscorthy,  
Co. Wexford, Ireland.  
Eircode: Y21PC98**

**FOLLOW US:**

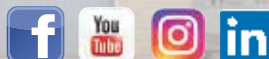

**RyansAutomotive**

**051 424 799**

Phone 051 424799  
email [info@ryansautomotive.ie](mailto:info@ryansautomotive.ie)  
visit [www.ryansautomotive.ie](http://www.ryansautomotive.ie)